

food service tapware

SUPERIOR PRE-RINSE

GUN TECHNOLOGY

USES LESS WATER

WORKS FASTER

SAVES MORE ENERGY



 **ULTRA-RINSE**
ENWARE AUSTRALIA PTY LIMITED

WWW.ENWARE.COM.AU

Ultra-Rinse pre-rinse spray gun

THE FS729 ULTRA-RINSE PRE-RINSE SPRAY GUN IS THE RESULT OF ENWARE'S WORLD-LEADING RESEARCH AND DEVELOPMENT

DESIGNED AND MANUFACTURED IN AUSTRALIA TO ACHIEVE AN IMPRESSIVE 6-STAR WATER EFFICIENCY RATING, THE ULTRA-RINSE INCORPORATES ADVANCED TECHNOLOGY IN ITS PLEASING ERGONOMIC DESIGN.

The superior high-velocity spray pattern cleans more efficiently, requiring less water per minute; cleaning faster with less effort. With the 6-Star WELS rating reflecting a flow rate of just four litres per minute, significant water-heating energy savings are an added bonus.

ENWARE'S ULTRA-RINSE PRE-RINSE GUN FEATURES INCLUDE:

- Proven durability in some of Australia's leading restaurants and fast food stores
- WaterMark approved, install with confidence
- Moulded rubber nozzle guard helps reduce the risk of damage from accidental knocks
- Easy to use, ergonomic handle design
- Chisel style spray pattern rapidly removes the food excess for less time spent at the sink
- High water efficiency, reduces water costs and the energy costs for heating the water
- Self-closing trigger spray turns off water when not in use
- Stay open ring keeps spray on for easier prolonged use
- Dual check valve for backflow prevention
- Can be retro-fitted to improve efficiency of existing units

ENWARE'S PRE-RINSE UNITS INCORPORATING ULTRA-RINSE

Enware's Pre-Rinse assemblies provide a wide range of options to suit your kitchen requirements. Built tough for the demands of busy commercial kitchens where performance and reliability is crucial.

Choose from wall or bench mounted configurations, with optional pot fillers for practical use of your sink area. We use premium quality hose, brass and stainless steel to give you maximum strength and dependability.

Complete pre-rinse assemblies incorporate a dual check valve for backflow prevention. Quarter turn non-rising jumper valve assemblies used in conjunction with lever handles allow for easy control of water.

Our modular design means Enware's pre-rinse units can easily be configured to meet your specific needs. And our Australian manufacturing plant means parts are always available for an even longer serviceable life.

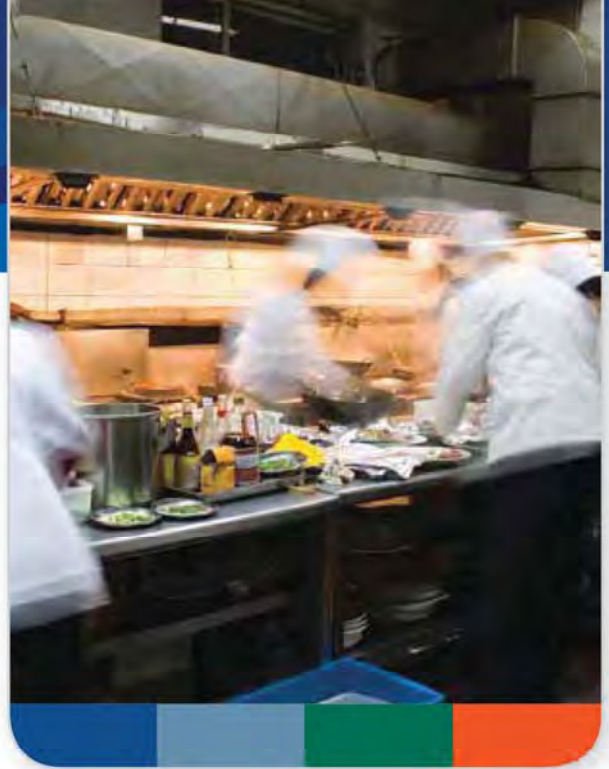

CONTENTS

HOB MOUNTED ASSEMBLIES PG 3

WALL MOUNTED ASSEMBLIES PG 5

OPTIONS & PARTS PG 7



WaterMark
AS/NZS 3718 WMKA 1583
SAI Global

Enware Tapware is manufactured to the exacting WaterMark standard AS/NZS3718 and AS4020.

WATER EFFICIENCY

ULTRA-RINSE PRE-RINSE SPRAY

WELS 6 Star (4 lpm) water efficiency rating.



POT FILLER WITH MANUAL SHUT-OFF

WELS 3 Star (7.7 lpm) water efficiency rating supplied standard.

Also available in 2 Star (9.1 lpm) or 5 Star (5.6 lpm) ratings – specify when ordering.



HOB MOUNTED ASSEMBLIES

All hob mounted Pre-Rinse units include 1/2" BSP Male connections. Overall height can be adjusted, contact Enware for more information.

PRE-RINSE ONLY

HOB MOUNTED PRE-RINSE UNIT WITH DUAL MIXER ASSEMBLY

Order Code:
FHS041

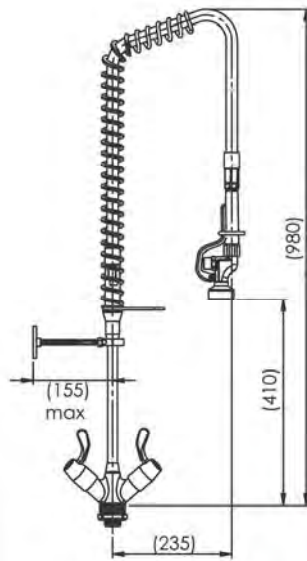

WITH POT-FILLER

HOB MOUNTED PRE-RINSE UNIT WITH DUAL MIXER ASSEMBLY WITH A POT FILLER

Order Code:
FHS141

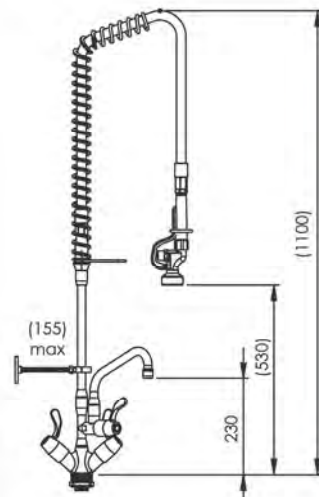

HOB MOUNTED PRE-RINSE UNIT WITH EXPOSED MIXER ASSEMBLY

Order Code:
FHS031 - 150mm centre*

**215mm width or adjustable centres are also available
Request when ordering*

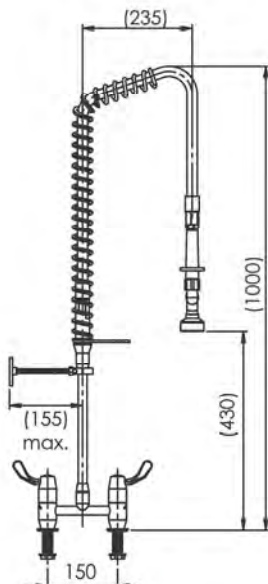

HOB MOUNTED PRE-RINSE UNIT WITH EXPOSED MIXER ASSEMBLY WITH A POT FILLER

Order Code:
FHS131 - 150mm centre*

**215mm width or adjustable centres are also available
Request when ordering*

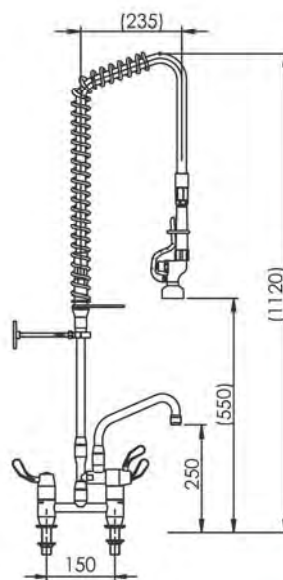

HOB MOUNTED ASSEMBLIES

PRE-RINSE ONLY

HOB MOUNTED PRE-RINSE UNIT WITH CONCEALED MIXER ASSEMBLY

Order Code:
FHS021 - Adjustable centre

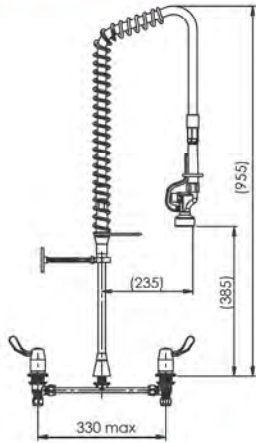

WITH POT-FILLER

HOB MOUNTED PRE-RINSE UNIT WITH CONCEALED MIXER ASSEMBLY WITH A POT FILLER

Order Code:
FHS121 - Adjustable centre

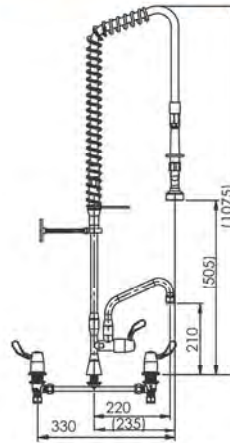

HOB MOUNTED PRE-RINSE UNIT WITH SINGLE CONTROL PRE-MIX ASSEMBLY

Order Code:
FHS011

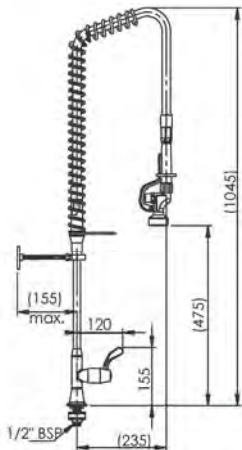

HOB MOUNTED PRE-RINSE UNIT WITH SINGLE CONTROL PRE-MIX ASSEMBLY WITH A POT FILLER

Order Code:
FHS111

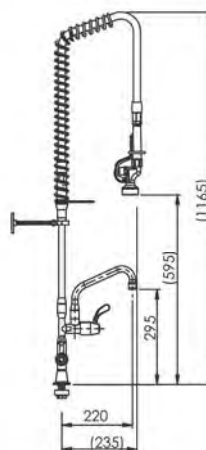

HOB MOUNTED RISER ASSEMBLY

Order Code:
FHS001

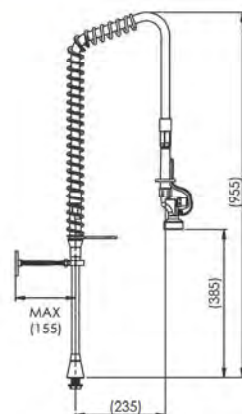

HOB MOUNTED RISER ASSEMBLY WITH A POT FILLER

Order Code:
FHS101

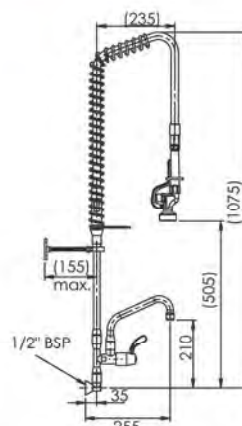

WALL MOUNTED ASSEMBLIES

All wall mounted Pre-Rinse units include 1/2" BSP Male connections. Overall height can be adjusted, contact Enware for more information.

PRE-RINSE ONLY

WALL MOUNTED PRE-RINSE UNIT WITH EXPOSED MIXER ASSEMBLY

Order Code:
FWS031 - 150mm centre*

**215mm width or adjustable centres are also available
Request when ordering*

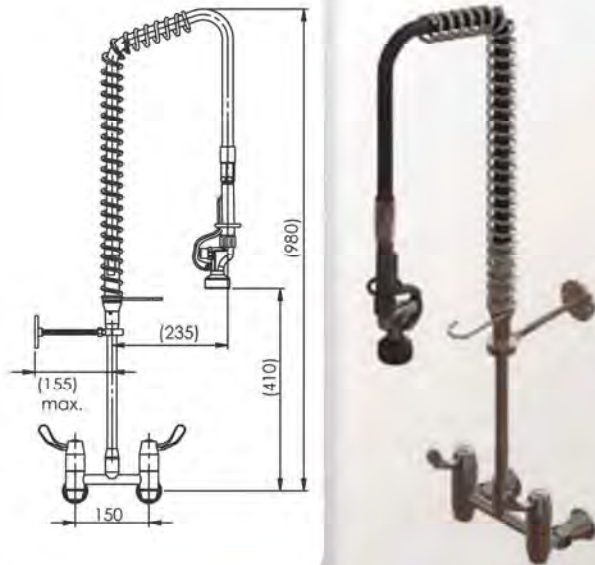

WITH POT-FILLER

WALL MOUNTED PRE-RINSE UNIT WITH EXPOSED MIXER ASSEMBLY WITH POT FILLER

Order Code:
FWS131 - 150mm centre*

**215mm width or adjustable centres are also available
Request when ordering*

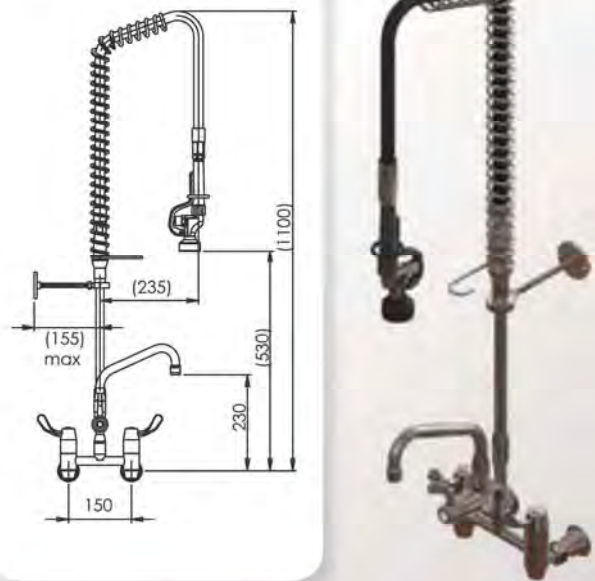

WALL MOUNTED PRE-RINSE UNIT WITH CONCEALED MIXER ASSEMBLY

Order Code:
FWS021

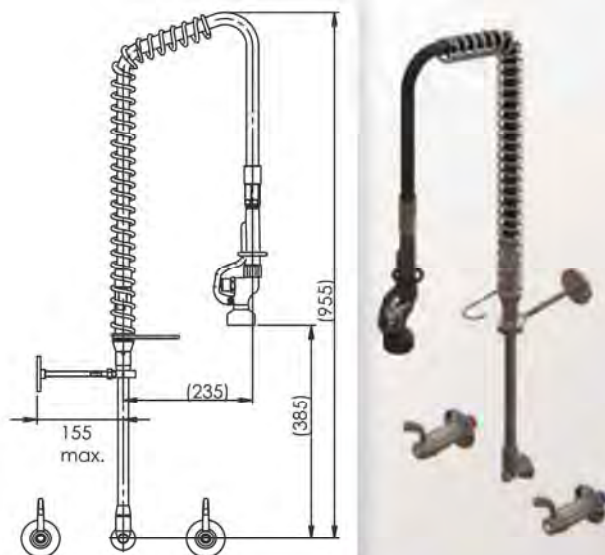

WALL MOUNTED PRE-RINSE UNIT WITH CONCEALED MIXER ASSEMBLY WITH A POT FILLER

Order Code:
FWS121

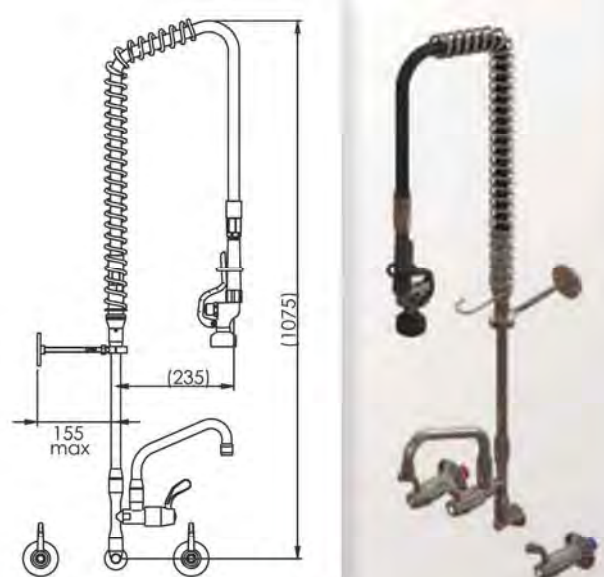

WALL MOUNTED ASSEMBLIES

PRE-RINSE ONLY

WALL MOUNTED PRE-RINSE UNIT WITH SINGLE CONTROL PRE-MIX ASSEMBLY

Order Code:
FWS011

WELS 6 Star (4 lpm) water efficiency rating

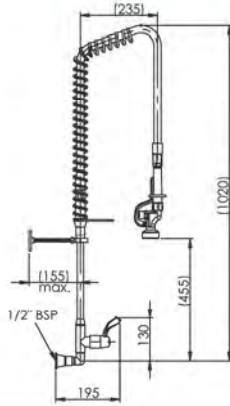

WITH POT-FILLER

WALL MOUNTED PRE-RINSE UNIT WITH SINGLE CONTROL PRE-MIX ASSEMBLY WITH A POT FILLER

Order Code:
FWS111

WELS 3 Star (7.7 lpm) water efficiency rating

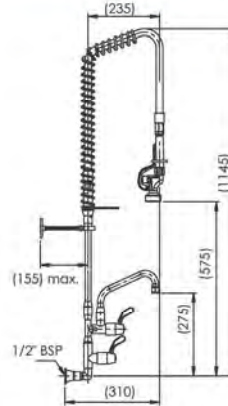

WALL MOUNTED RISER ASSEMBLY

Order Code:
FWS001

WELS 6 Star (4 lpm) water efficiency rating

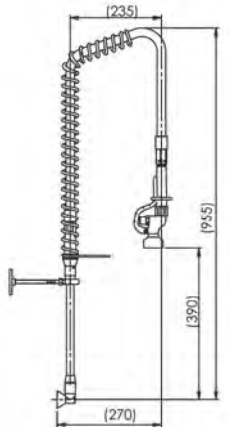

WALL MOUNTED RISER ASSEMBLY WITH A POT FILLER

Order Code:
FWS101

WELS 3 Star (7.7 lpm) water efficiency rating

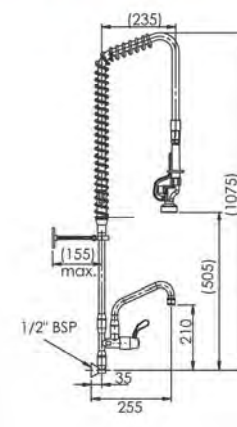

Our modular component design and flexible manufacturing allows customising to suit your specific needs. The compact version shown here suits applications where there is not much height available above the sink. Contact your Enware representative about any special requirements you have.

WALL MOUNTED PRE-RINSE UNIT WITH CONCEALED MIXER ASSEMBLY AND POT FILLER - COMPACT VERSION (LESS RISER)

Order Code:
FWS121W

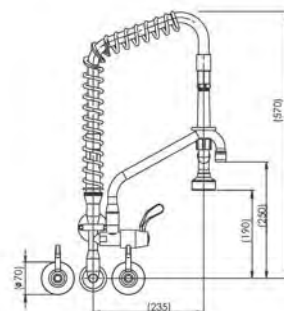

PRE-RINSE ASSEMBLIES – OPTIONS AND PARTS

Enware's modular design and Australian manufacturing means we can easily customise our products to meet specific application requirements. This section is provided as a guide to the options available and our customer service team can help with your special requirements.

THE LABELS REFER TO THE PARTS AND OPTIONS BELOW.

Order Code:
FHS141 - Pre-rinse unit with optional pot filler shown here.

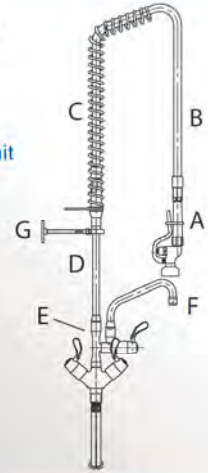

A: TRIGGER SPRAYS

ULTRA-RINSE PRE-RINSE TRIGGER SPRAY

Order Code:
FS729

Rapid rinsing design, with WELS 6 star rating. This spray is supplied standard on Enware pre-rinse assemblies.

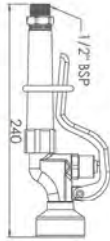

ULTRA-SPRAY SOFT RINSE TRIGGER SPRAY

Order Code:
FS729SS

This optional spray is designed for applications where a gentler spray is preferred. The head rotates to alternate between an aerated spray or a shower stream pattern.

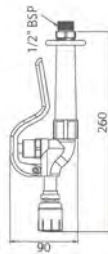

B: HEAVY DUTY HOSE

PRE-RINSE HOSE WITH SWIVEL AND 15MM BSP CONNECTIONS

Order Code:
A

- FS104: 400mm
- FS106: 600mm
- FS109: 900mm
- FS110: 1000mm (Standard)
- FS111: 1100mm
- FS115: 1500mm



C: STAINLESS SPRING

STAINLESS STEEL SPRING RETURN

Order Code:
A

- FS100: 585MM (standard)
- FS101: 385MM (optional)



D: RISER

RISER

Order Code:
A

- FS051: 100mm (optional)
- FS053: 300mm (standard)
- FS056: 600mm (optional)
- FS059: 900mm (optional)



E: POT FILLER ADAPTOR

POT FILLER ADAPTOR

Order Code:
FS063

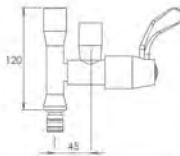

F: SPOUT OPTIONS

ANGULAR OUTLET WITH AERATOR

Order Code:

- | | A | B |
|-------|-------|-------|
| FS180 | 180mm | 65mm |
| FS181 | 230mm | 105mm |
| FS182 | 300mm | 125mm |

CURVED OUTLET WITH AERATOR

Order Code:

- | | A | B |
|-------|-------|-------|
| FS184 | 150mm | 100mm |
| FS185 | 200mm | 135mm |

LONG REACH SWIVEL ARM WITH 1/2" BSP THREAD

Order Code:

- | | A | B |
|-------|-------|------|
| FS188 | 150mm | 55mm |
| FS187 | 300mm | 75mm |

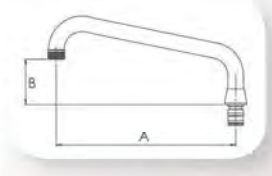
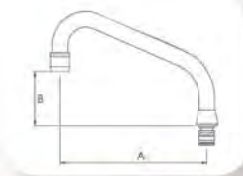

ADJUSTABLE WALL BRACKET

Order Code:
FS070

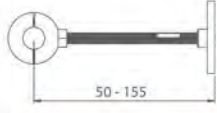

RELATED PRODUCTS

HOT AND COLD WASH DOWN HOSE REEL

Order Code:

- FS724 - with FS731 Floor Wash Nozzle
- FS728 - with FS722 Adjustable Wash Down Spray

Pictured with light duty, easy to use FS731 trigger spray with "stay on" clasp. Also available with a variety of attachments including FS722 heavy duty trigger



TRIGGER SPRAY WITH FLOOR WASH NOZZLE

Order Code:
FS731



HEAVY DUTY ADJUSTABLE WASH DOWN SPRAY

Order Code:
FS722



HAND HELD TRIGGER SPRAY WITH SP325 FIXED SPRAY NOZZLE

Order Code:

- FWS730DL**
- Trigger Spray Only

FWS729D

- 1m hose and wall bracket

FWS730D

- 1.5m hose and wall bracket

FWS830D

- 3m hose and wall bracket



TECHNICAL INFORMATION

Recommended Working Pressure:	50 - 500*kPa
*Maximum outlet pressure in accordance with AS/NZS3500:	500 kPa
Maximum Working Temperature:	90° C

For optimum performance it is recommended that the control valves or taps be turned off when not in use overnight or for long periods.

Complete pre-rinse assemblies incorporate a dual check valve for backflow prevention. Lever tapware control incorporate quarter turn non-rising jumper valves.

Enware products are to be installed in accordance with AS/NZS3500.

NOTE: Enware Australia advises -

1. Due to ongoing Research and Development, specifications may change without notice.
2. All dimensions are in mm and are provided as a guide only. Minor variations may occur due to the manufacturing process.

ALSO AVAILABLE FROM ENWARE

CUBISTA ELECTRONIC TAPWARE

Sensor activated basin tap for hands free hygiene. Incorporates the latest triangulation sensor technology. Optional temperature adjuster included.

Order Code:
ENM6450

WELS 6 Star (5.4 lpm) water efficiency rating supplied



WALL MOUNTED SENSOR ACTIVATED TIME FLOW TAP

Infra-red sensor activates the water flow for a programmable set time. Factory set at 6 seconds.

Order Code:
ENM5071

WELS 5 Star (5.9 lpm) water efficiency rating supplied



150MM LEVA WALL MOUNTED MIXING SET

A wide range of lever action tapware for elbow operation. Refer to our LEVA Tapware brochure.

Order Code:
LEV150402

WELS 3 Star (7.7 lpm) water efficiency rating supplied as standard. Also available in 2 (9.1 lpm) 5 (5.6 lpm) Star ratings



KNEE OPERATED BASIN KIT

Includes basin outlet, knee operation mechanism, flexible hose and isolation valves.

Order Code:
HFS780

WELS 4 Star (7.7 lpm) water efficiency rating supplied as standard. Also available in 3 (9.1 lpm) 5 (5.9 lpm) and 6 (5.6 lpm) Star ratings



WATERWARE INSTANT BOILING WATER

Provide the convenience of instant boiling water. Available in 3 capacities and feature a programmable timer to help maximise energy efficiency.

Order Code:

WBLU030 - 3 litre capacity (123 cups first hour)
WBLU050 - 5 litre capacity (158 cups first hour)
WBLU075 - 7.5 litre capacity (173 cups first hour)



WATERWARE FREE STANDING CHILLERS

Provide refreshing chilled water with the Waterware range of free standing chillers. Filter option or under-counter units are also available.

Order Code:

DFS121 - Free standing chiller with glass filter



FRANKE BASINS AND SINKS

Choose from a wide selection of sinks and basins from the Franke Washroom Systems commercial range. Enware can combine with tapware for dedicated hand wash solutions. Pictured here is a Combi-Basin with tapware, soap dispenser and paper towel dispenser. Contact your Enware representative for more information.



FRANKE WASHROOM ACCESSORIES

Choose from a wide range of stainless steel washroom accessories from the Franke Washroom Systems commercial range. Includes hands free soap dispensers for dedicated hand wash areas and a full range of accessories for restrooms.

Order Code:

RODX619



ENWARE IN BRIEF

Enware is a world-leading Australian designer and manufacturer of quality specialist commercial tapware solutions and safety systems.

Since inception in 1937, Enware Australia has grown significantly. Today, Enware has offices located around the country and is represented in major regions throughout the world including Asia, the Pacific, the Middle East and Europe. As a global leader of specialist tapware and safety systems, Enware offers a more extensive range than any other company on the market.

SPECIALIST
PLUMBING SOLUTIONS

ADAPTABLE WORK
& LIVING SOLUTIONS

ENVIRONMENTAL, HEALTH
& SAFETY SOLUTIONS

STAINLESS STEEL
WASHROOM SYSTEMS



ADDRESS: 9 Endeavour Road, Caringbah NSW 2229 Australia
POSTAL ADDRESS: P.O. Box 2545, Taren Point NSW 2229 Australia
PHONE: 61 2 8556 4000 FAX: 61 2 8556 4055
1300 369 273 (AUS) WWW.ENWARE.COM.AU INFO@ENWARE.COM.AU

